

Article number: 0102173

Description: Retaining ring J250 DIN472  
Spring steel

## Measures

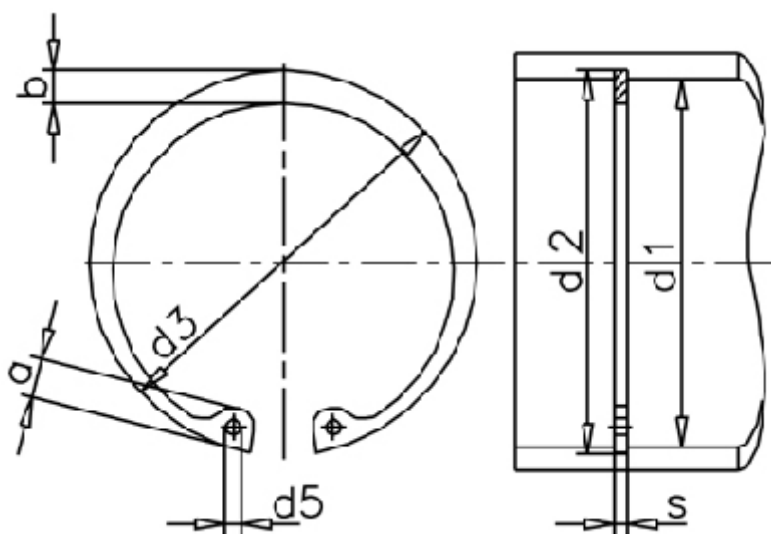

a max	= 14.2	FN kN	= 396.00	t	= 3.00
AN mm <sup>2</sup>	= 2380.0	FRg kN	= 75.0	tol	= +0,81
b	= 14.0	FR kN	= 504.0	tol	= +2,00-0,81
d1	= 250	g	= 4.0	tol	= -0.12
d2	= 256.0	K kN-mm	= 1155.0	Tong	= ZGJ-5
d3	= 262.00	m min	= 5.15	Weight kg/1000	= 360.00
d5 min	= 4.0	Nominal drive	= 9.0		
Description = J 250		s	= 5.00		